

M8 male 90° / RJ45 male 0° shielded EC

PUR 1x4xAWG26 shielded gn UL/CSA+drag chain 7,5m

Ethernet CAT5

Male 90° – male straight

M8 – RJ45, 4-pole

shielded

Attention: Contact carrier turned to 180°!

Further cable lengths on request.

Plastic housings with good resistance against chemicals and oils.

The resistance to aggressive media should be individually tested for your application. Further details on request.

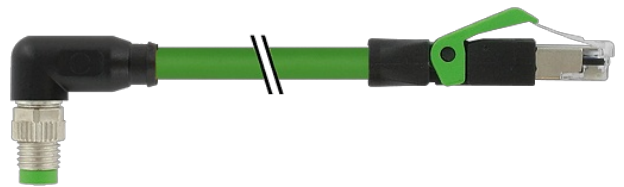
[Link to Product](#)**Illustration**

Product may differ from Image

More Info**Form**

Form 89782

General data

Pollution Degree	3
Temperature range	-20...+80 °C, depending on cable quality

Cables

No./diameter of wires	1 x 4 x 0.15 mm ²
Wire isolation	PO (wh, ye, bl, or)
C-track properties	5 Mio.
Material (jacket)	PUR (UL/CSA)
Outer Ø	4.9 mm ±5%
Bend radius (moving)	12x outer Ø
Temperature range (fixed)	-20...+80 °C
Temperature range (mobile)	-20...+50 °C
Cable identification	791
Approval (cable)	UL (AWM-Style 20236/1589), CSA; CE
Cable weight [g/m]	59,40
Material (wire)	Cu wire, bare
Resistor (core)	max. 139.3 Ω/km (20 °C)
Single wire Ø (core)	0.15 mm
Construction (core)	19x 0.15 mm (multi-strand wire class 5)

Diameter (core)	1 × 4 × AWG26
AWG	similar to AWG 26
Material (wire isolation)	PO
Wire-Ø incl. isolation	1.0 mm ±5%
Color/numbering of wires	wh, or, bl, ye
Stranding combination	4 wires twisted
Shield	yes
	min. 85%
Material (jacket)	PUR
Material property (jacket)	CFC-, halogen-, cadmium-, silicone- and lead-free
Outer-Ø (jacket)	4.9 mm ±5%
Color (jacket)	green
chemical resistance	good resistance to oil, gasoline and chemicals
thermal resistance	flame retardant
Temperature range (fixed)	-20...+80 °C
Temperature range (mobile)	-20...+50 °C
Bend radius (fixed)	7.5 × outer Ø
Bend radius (moving)	12 × outer Ø
No. of bending cycles (C-track)	max. 5 Mio. (25 °C)
Traversing distance (C-track)	max. 5 m (horizontal)
Travel speed (C-track)	max. 300 m/min
Acceleration (C-track)	max. 5 m/s ²
Jacket Color	green

Technical Data

Operating voltage	max. 30 V AC/DC
Operating current per contact	max. 1.5 A (20 °C)
Material group	IEC 60664-1, category I
Transfer parameters	CAT5, Class D (ISO/IEC 11801:2002), (EN 50173-1)
Transfer rate	up to 100 Mbit/s full duplex
Locking of ports	Screw thread (M8×1 mm) recommended torque 0.4 Nm, self-securing
Compression gland	M8 (SW9)
Protection	IP65, IP66K, IP67 (M8) - IP20 (RJ45)
Locking material	Zinc die casting, nickel-plated
Material	PUR
suitable for corrugated tube (internal Ø)	6.5 mm
Rated surge voltage	0.8 kV

Commercial data

country of origin	DE
customs tariff number	85444210
EAN	4048879611305
eClass	27061801
Packaging unit	1

Sketch

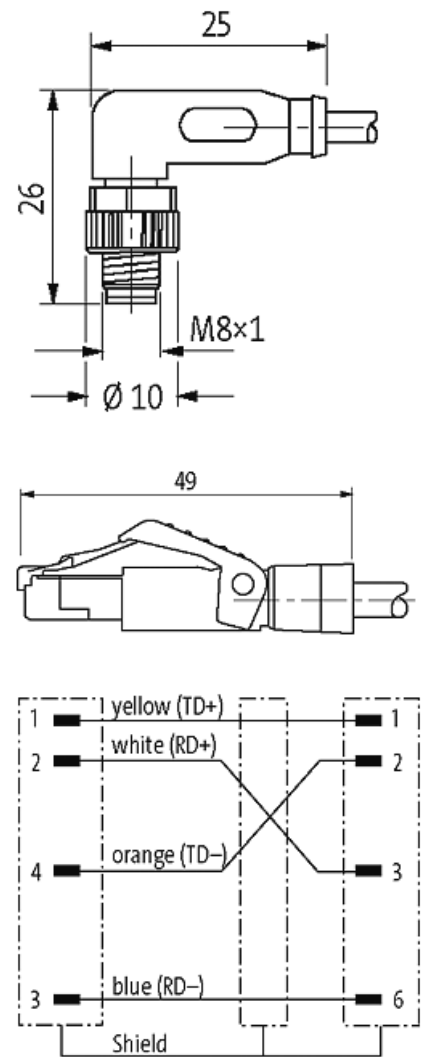

Product may differ from Image